



CONTROL THE SUN. SAVE THE WORLD.

**AUTHORIZED, 3M WINDOW FILM DEALER
PRESTIGE DEALER NETWORK**



Founded in 1958, AKRON GLASS TINTING specializes in

- Solar-control window film
- Safety & security window film
- Beautiful custom privacy film
- Architectural finishes

AWARDS:

- 2013 3M Dealer of the Year - Midwest
- 2012 3M Market Leadership Award
- 2007 New Dealer of the Year, 3M Window Film
- 2006 Associate Tradesman of the Year - Akron HBA
- 2003 Greg Seib Spirit Award - Akron HBA

Recently, AGT has installed 3M window film to the following buildings:

INFOCISION STADIUM, UNIVERSITY OF AKRON, THE POLSKY BUILDING, UNIVERSITY OF AKRON, POLYMER EDUCATION ACADEMIC CENTER, 24100 CHAGRIN ROAD OFFICE BUILDING, GOODYEAR CORPORATE HQ, OSU'S BIOMEDICAL RESEARCH TOWER, RAVENNA COURTHOUSE, RAVENNA ADMINISTRATIVE BUILDING, RAVENNA'S HISTORIC RIDDLE BLOCK, JACKSON HIGH SCHOOL.

Learning Objectives

A VERY brief summary for facility professionals...

- SAFETY AND SECURITY FILM
- DECORATIVE PRIVACY FILM
- DAYLIGHT REDIRECTION FILM
- ARCHITECTURAL FINISHES

TODAY'S MAIN FOCUS

- SOLAR CONTROL FILM FOR BUILDING ENVELOPES

Safety & Security Film Benefits



Safety Glazing

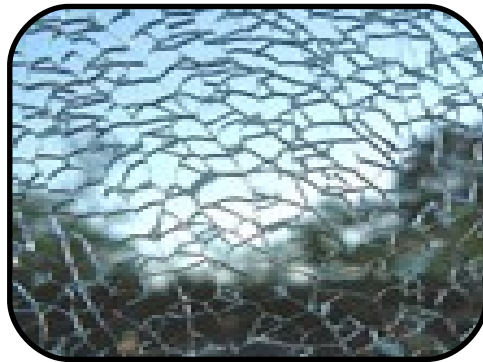

**Spontaneous
Glass Breakage**



**Intrusion
Protection**



**Blast
Mitigation**



Windstorm



Anti Graffiti

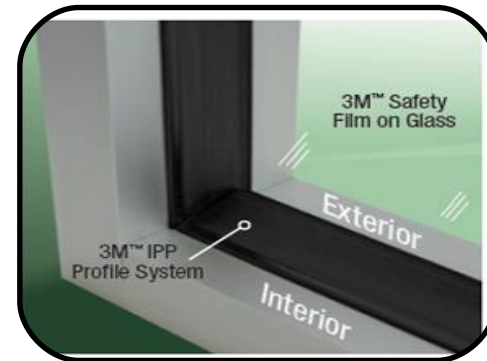

**Attachment
Systems**

Intrusion Protection

- Windows are one of the weakest points on your building
- In 2012, over \$15B was lost due to property related crimes in the US
- Upgrading to fortified glass is very expensive



2012 US Crime Statistics*	
Property Crimes	Violent Crimes
Occur every 3.5 seconds	Occur every 26 seconds
Nearly 9 million occurrences	Over 1.2 million occurrences

*According to the Uniform Crime Report "Crime in the United States", 2012 completed by the US FBI

**Note: Window Films are not bullet proof, they provide intrusion protection

Attachment Systems

Attachment Systems help contain filmed broken glass in the window frame

- Create a bond between the film and the frame to anchor the glass

Designed to mimic the look of a standard rubber gasket in the window

- Typically come in one of two forms, a wet glaze, or rubber gasket with VHB adhesive

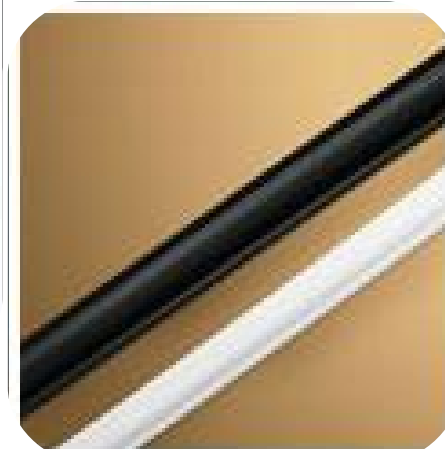
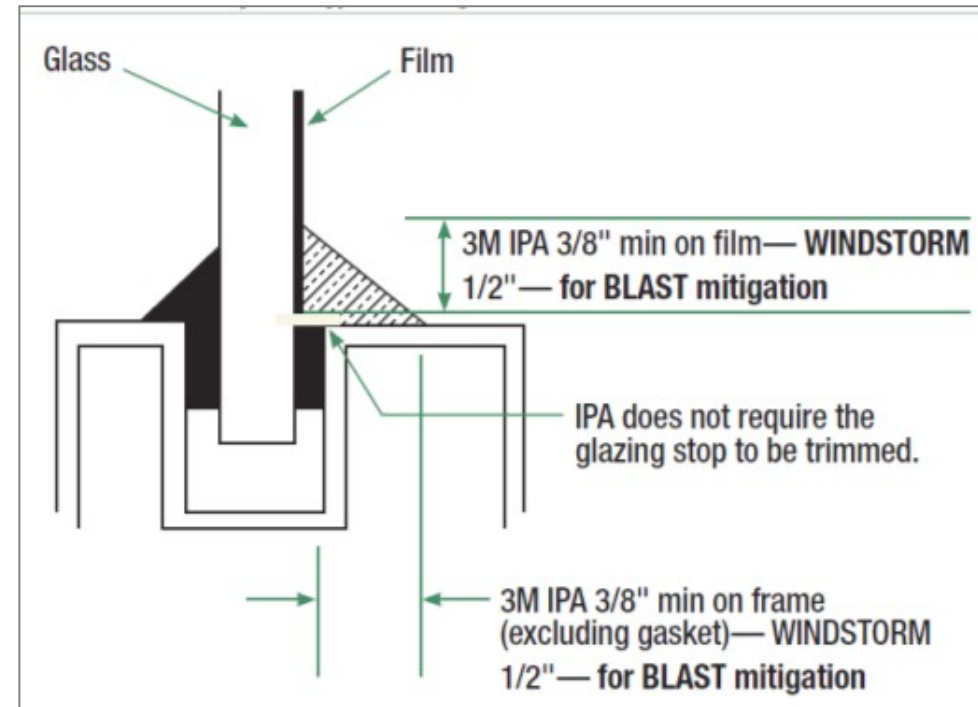

BLAST MITIGATION

FORCED ENTRY



EXIT

Decorative Window Film





We specialize in
custom-cut vinyl for
decorative privacy and
architectural interest.



HONESTY

COLLABORATION

PASSIONATE

GIVE

KNOWLEDGEABLE

IMPROVE

ACHIEVE

PRIORITY



4
STEN

STEIN

DAHL

CK

ME

HEMINGWAY

SEUSS

SILVERSTEIN

ANGELLO

GERALD

LOREA



*Choose from hundreds of
pre-patterned and matte films*



Daylight Redirecting Film

- Redirects natural light to the ceiling to increase comfort and provide natural light deeper in the building.
- Can be used in new construction or existing buildings
- Easily installed

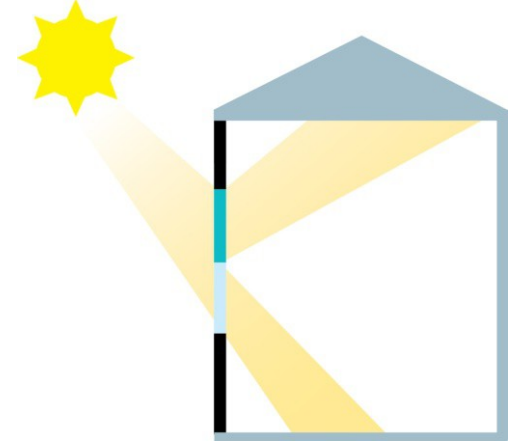

No Film



With Film





Before



SMUD – Sacramento, California

Daylight Redirecting Film Summary*

- 
- Redirects up to 80% of the light up towards the ceiling
 - Redirects natural light up to 40' deep into the building
 - No additional maintenance or special cleaning needed to maintain performance
 - Extends daylight zone up to 8' for every 1 ft of treated window
 - Cost effective compared to other daylighting solutions
 - Up to 52% lighting energy savings compared to baseline usage
 - Savings of up to 1.5 kwh/sqft of floor area

*Claims based on studies completed by, or in conjunction with, US Department of Defense, Lawrence Berkeley National Laboratories (LBNL), Louiso + Ubbelohde architecture (L+U), Sacramento Municipal Utilities Department (SMUD)

ARCHITECTURAL FINISHES



MANNY HONDROULIS

Technical Associate for Energy Products Distribution (EPD), exclusive distributor of 3M Window Film products in the Northeast, Southeast, and Eastern Midwest United States.

In this position, Manny works with building owners, property managers, and ESCOs to reduce the inefficiencies associated with glazing. From building modeling to filing for custom incentives (utility rebates), Manny helps the end-users make an informed decision about whether or not window film is an appropriate solution for a given building. He has been with EPD since 2002.





9

**Blue
Elevators**

BEFORE



10

Blue

AFTER

OVER 500 DIFFERENT
PATTERNS AND TEXTURES.
REPURPOSE ALMOST
ANY SMOOTH SUBSTRATE

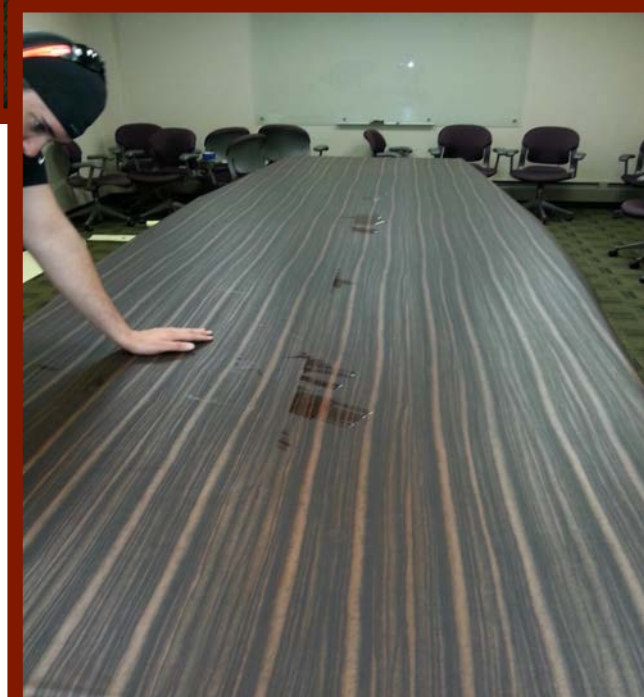

Thank you



CONTROL THE SUN. SAVE THE WORLD.

